

design	0.3m	
	0.6m	
	1.0m	
	1.5m	
	2.0m	
	3.0m	
	5.0m	
connector	M8 / M8	3-pin
	M12 / M8	3-pin
	M12 / M8	4-pin
	M8 / M12	3-pin
	M12 / M12	4-pin
	M12 / M8 (2x)	4-pin
		3-pin



- ✓ suitable for trailing chain
- ✓ black PUR cable, halogen- and silicone-free
- ✓ straight or angular cable sockets
- ✓ straight cable connectors
- ✓ IP67 system of protection when screwed down
- ✓ wire colors to EURONORM
- ✓ LED-display for switching output and operating voltage

ipf-SENSORFLEX®
ready-made connection cables



description

Today, actuator and sensor cables are some of the most important components in the field of connection technology. They are used as connections between sensors/actuators and distribution terminals and/or field bus modules. Extruded onto one side of the **ipf-SENSORFLEX®** lead is a coupling (socket) and on the other side, a connector. Depending on the embodiment, these come with an M8x1 or an M12x1 thread. The extrusion mould offers particularly good protection against the infiltration of moisture and dirt. All

leads fulfill system of protection IP67 as a minimum standard.

The outstanding features of the connection cable are:

- ▶ high mechanical-dynamic resilience
- ▶ halogen-free, silicon-free and PVC-free
- ▶ suitable for trailing chain
- ▶ resistant to coolants and lubricants
- ▶ good impermeability and vibration resistance

connector:	M8, straight	M8, straight	M8, straight
socket:	M8, angular	M8, angular, 2 LED	M8, straight
number of pins:	3-pin	3-pin	3-pin
article-no.	VK030F70	VK030F72	VK030F74
length	0.3m	0.3m	0.3m
article-no.	VK060F70	VK060F72	VK060F74
length	0.6m	0.6m	0.6m
article-no.	VK100F70	VK100F72	VK100F74
length	1.0m	1.0m	1.0m
article-no.	VK150F70	VK150F72	VK150F74
length	1.5m	1.5m	1.5m
article-no.	VK200F70	VK200F72	VK200F74
length	2.0m	2.0m	2.0m
article-no.	VK300F70	VK300F72	VK300F74
length	3.0m	3.0m	3.0m
article-no.	VK500F70	VK500F72	VK500F74
length	5.0m	5.0m	5.0m

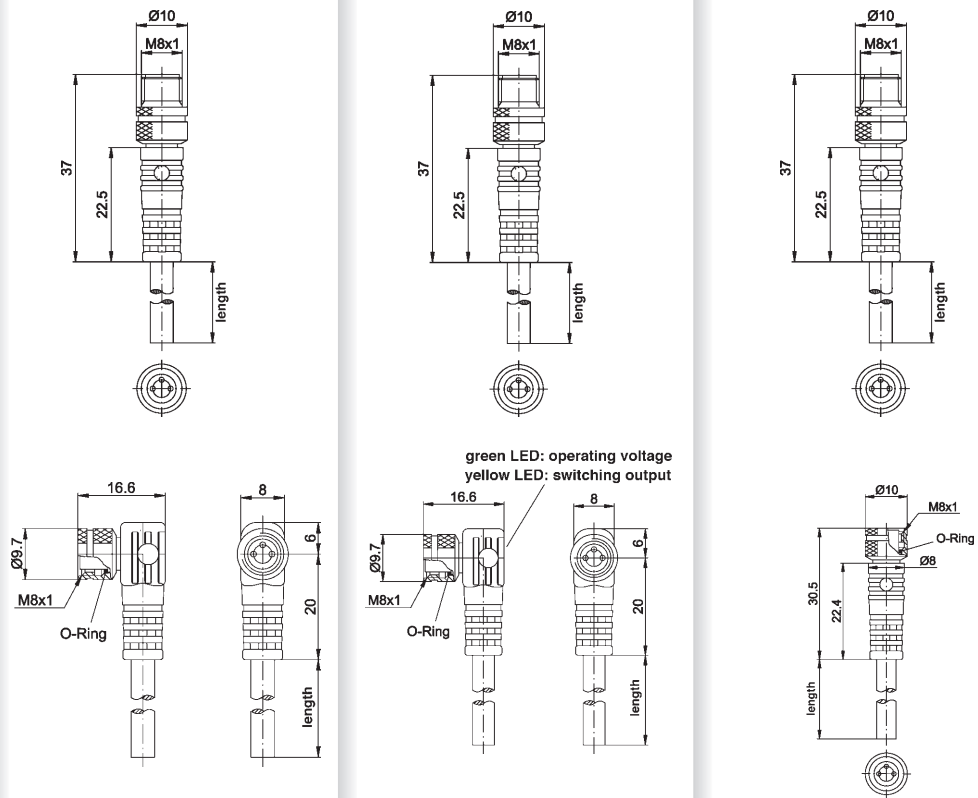

TECHNICAL DATA

voltage (U _N) without LED	60V DC / AC _{eff}	-	60V DC / AC _{eff}
voltage (U _N) with LED	-	10 ... 30V DC	-
display (operating voltage)	-	green LED (contact 1)	-
display (switching output)	-	yellow LED (contact 4)	-
wire assembly	43 x 0.1mm	43 x 0.1mm	43 x 0.1mm
wire cross section	0.34 mm ²	0.34 mm ²	0.34 mm ²
outer jacket	PUR	PUR	PUR
ambient temperature	-25 ... +80°C	-25 ... +80°C	-25 ... +80°C
system of protection (EN 60529)	IP67	IP67	IP67
wire colors	1/brown 3/blue 4/black	1/brown 3/blue 4/black	1/brown 3/blue 4/black

connection cables connection technology 1100

connector:	M12, straight	M12, straight	M12, straight
socket:	M8, angular	M8, angular, 2 LED	M8, straight
number of pins:	3-pin	3-pin	3-pin
article-no.	VK030F80	VK030F82	VK030F84
length	0.3m	0.3m	0.3m
article-no.	VK060F80	VK060F82	VK060F84
length	0.6m	0.6m	0.6m
article-no.	VK100F80	VK100F82	VK100F84
length	1.0m	1.0m	1.0m
article-no.	VK150F80	VK150F82	VK150F84
length	1.5m	1.5m	1.5m
article-no.	VK200F80	VK200F82	VK200F84
length	2.0m	2.0m	2.0m
article-no.	VK300F80	VK300F82	VK300F84
length	3.0m	3.0m	3.0m
article-no.	VK500F80	VK500F82	VK500F84
length	5.0m	5.0m	5.0m

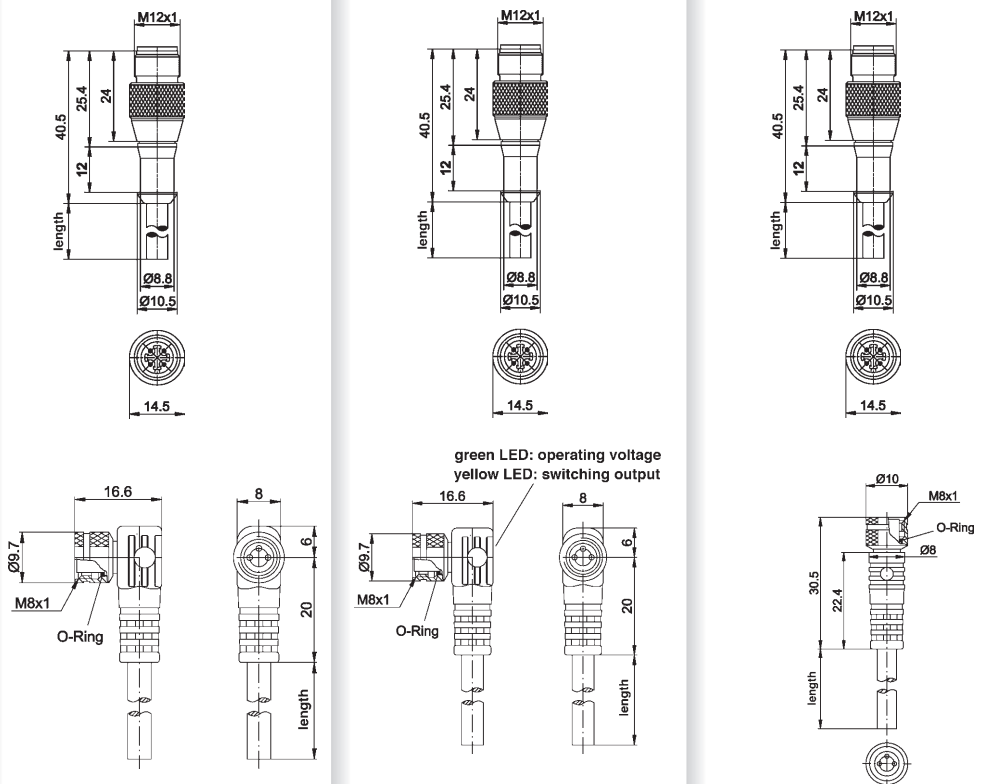
TECHNICAL DATA

voltage (U _N) without LED	60V DC / AC _{eff}	-	60V DC / AC _{eff}
voltage (U _N) with LED	-	10 ... 30V DC	-
display (operating voltage)	-	green LED (contact 1)	-
display (switching output)	-	yellow LED (contact 4)	-
wire assembly	43 x 0.1mm	43 x 0.1mm	43 x 0.1mm
wire cross section	0.34 mm ²	0.34 mm ²	0.34 mm ²
outer jacket	PUR	PUR	PUR
ambient temperature	-25 ... +80°C	-25 ... +80°C	-25 ... +80°C
system of protection (EN 60529)	IP67	IP67	IP67
wire colors	1/brown 3/blue 4/black	1/brown 3/blue 4/black	1/brown 3/blue 4/black

connector:	M12, straight	M12, straight
socket:	M8, angular	M8, straight
number of pins:	4-pin	4-pin
article-no.	VK030F81	VK030F85
length	0.3m	0.3m
article-no.	VK060F81	VK0630F85
length	0.6m	0.6m
article-no.	VK100F81	VK100F85
length	1.0m	1.0m
article-no.	VK150F81	VK150F85
length	1.5m	1.5m
article-no.	VK200F81	VK200F85
length	2.0m	2.0m
article-no.	VK300F81	VK3030F85
length	3.0m	3.0m
article-no.	VK500F81	VK500F85
length	5.0m	5.0m

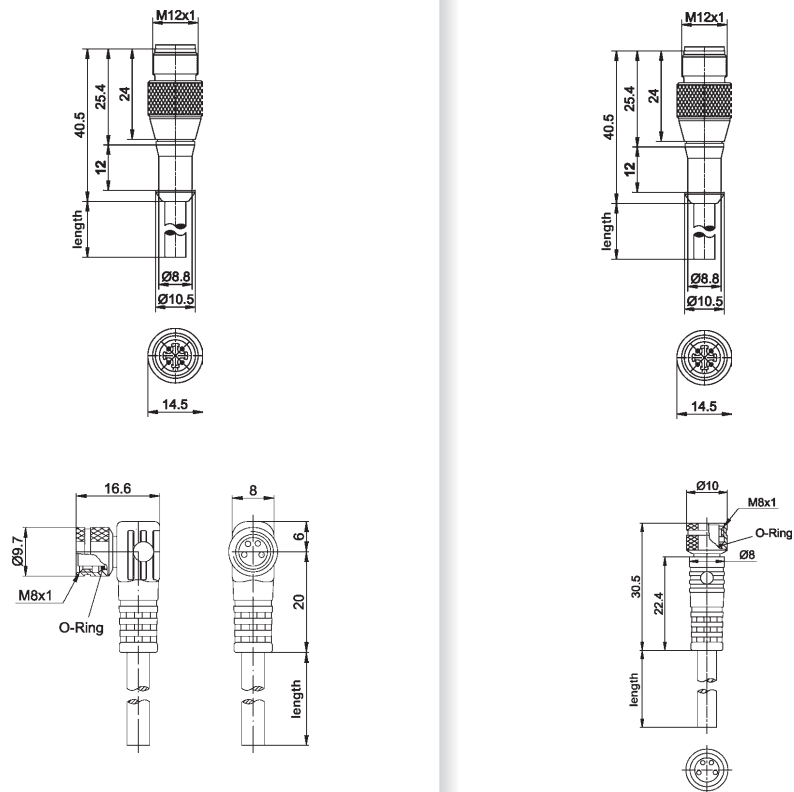

TECHNICAL DATA

voltage (U _N) without LED	60V DC / AC _{eff}	60V DC / AC _{eff}
voltage (U _N) with LED	-	-
display (operating voltage)	-	-
display (switching output)	-	-
wire assembly	43 x 0.1mm	43 x 0.1mm
wire cross section	0.34 mm ²	0.34 mm ²
outer jacket	PUR	PUR
ambient temperature	-25 ... +80°C	-25 ... +80°C
system of protection (EN 60529)	IP67	IP67
wire colors	1/brown 2/white 3/blue 4/black	1/brown 2/white 3/blue 4/black

connection cables connection technology 1100

connector:	M8, straight	M8, straight	M8, straight
socket:	M12, angular	M12, angular, 2 LED	M12, straight
number of pins:	3-pin	3-pin	3-pin
article-no.	VK030F60	VK030F62	VK030F64
length	0.3m	0.3m	0.3m
article-no.	VK060F60	VK060F62	VK060F64
length	0.6m	0.6m	0.6m
article-no.	VK100F60	VK100F62	VK100F64
length	1.0m	1.0m	1.0m
article-no.	VK150F60	VK150F62	VK150F64
length	1.5m	1.5m	1.5m
article-no.	VK200F60	VK200F62	VK200F64
length	2.0m	2.0m	2.0m
article-no.	VK300F60	VK300F62	VK300F64
length	3.0m	3.0m	3.0m
article-no.	VK500F60	VK500F62	VK500F64
length	5.0m	5.0m	5.0m

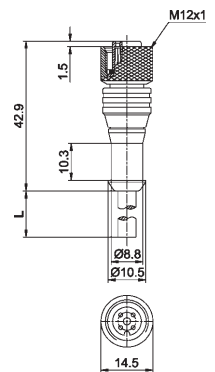
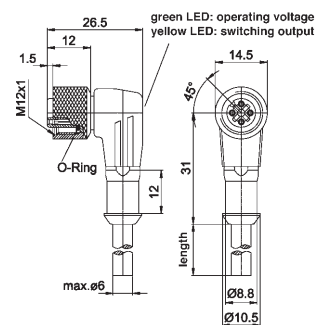
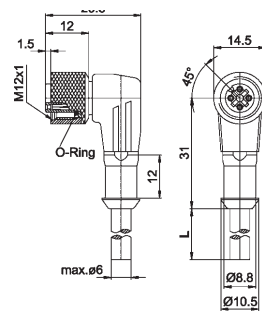
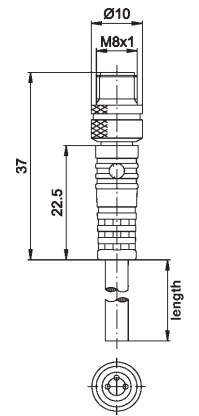
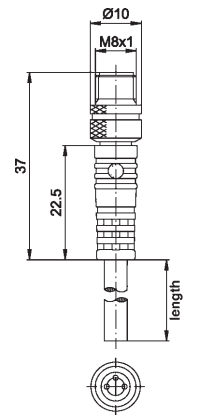
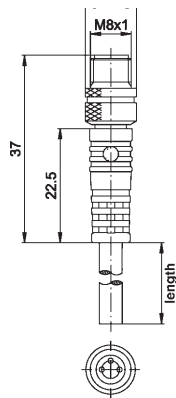
TECHNICAL DATA

voltage (U _N) without LED	60V DC / AC _{eff}	-	60V DC / AC _{eff}
voltage (U _N) with LED	-	10 ... 30V DC	-
display (operating voltage)	-	green LED (contact 1)	-
display (switching output)	-	yellow LED (contact 4)	-
wire assembly	43 x 0.1mm	43 x 0.1mm	43 x 0.1mm
wire cross section	0.34 mm ²	0.34 mm ²	0.34 mm ²
outer jacket	PUR	PUR	PUR
ambient temperature	-25 ... +80°C	-25 ... +80°C	-25 ... +80°C
system of protection (EN 60529)	IP67	IP67	IP67
wire colors	1/brown 3/blue 4/black	1/brown 3/blue 4/black	1/brown 3/blue 4/black

connector:	M12, straight	M12, straight
socket:	M12, angular	M12, straight
number of pins:	4-pin	4-pin
article-no.	VK030F21	VK030F25
length	0.3m	0.3m
article-no.	VK060F21	VK060F25
length	0.6m	0.6m
article-no.	VK100F21	VK100F25
length	1.0m	1.0m
article-no.	VK150F21	VK150F25
length	1.5m	1.5m
article-no.	VK200F21	VK200F25
length	2.0m	2.0m
article-no.	VK300F21	VK300F25
length	3.0m	3.0m
article-no.	VK500F21	VK500F25
length	5.0m	5.0m

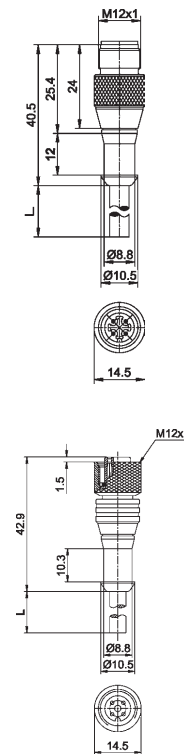
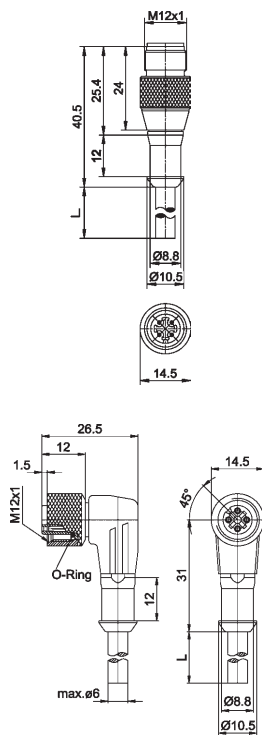

TECHNICAL DATA

voltage (U _N) without LED	240V DC / AC _{eff}	240V DC / AC _{eff}
voltage (U _N) with LED	-	-
display (operating voltage)	-	-
display (switching output)	-	-
wire assembly	43 x 0.1mm	43 x 0.1mm
wire cross section	0.34 mm ²	0.34 mm ²
outer jacket	PUR	PUR
ambient temperature	-25 ... +80°C	-25 ... +80°C
system of protection (EN 60529)	IP67	IP67
wire colors	1/brown 2/white 3/blue 4/black	1/brown 2/white 3/blue 4/black

connection cables connection technology 1100

connector:	M12, straight	M12, straight
socket:	M12, angular, 3 LED	M12, straight, 2 LED
number of pins:	4-pin	4-pin
article-no.	VK030F23	VK030F26
length	0.3m	0.3m
article-no.	VK060F23	VK060F26
length	0.6m	0.6m
article-no.	VK100F23	VK100F26
length	1.0m	1.0m
article-no.	VK150F23	VK150F26
length	1.5m	1.5m
article-no.	VK200F23	VK200F26
length	2.0m	2.0m
article-no.	VK300F23	VK300F26
length	3.0m	3.0m
article-no.	VK500F23	VK500F26
length	5.0m	5.0m

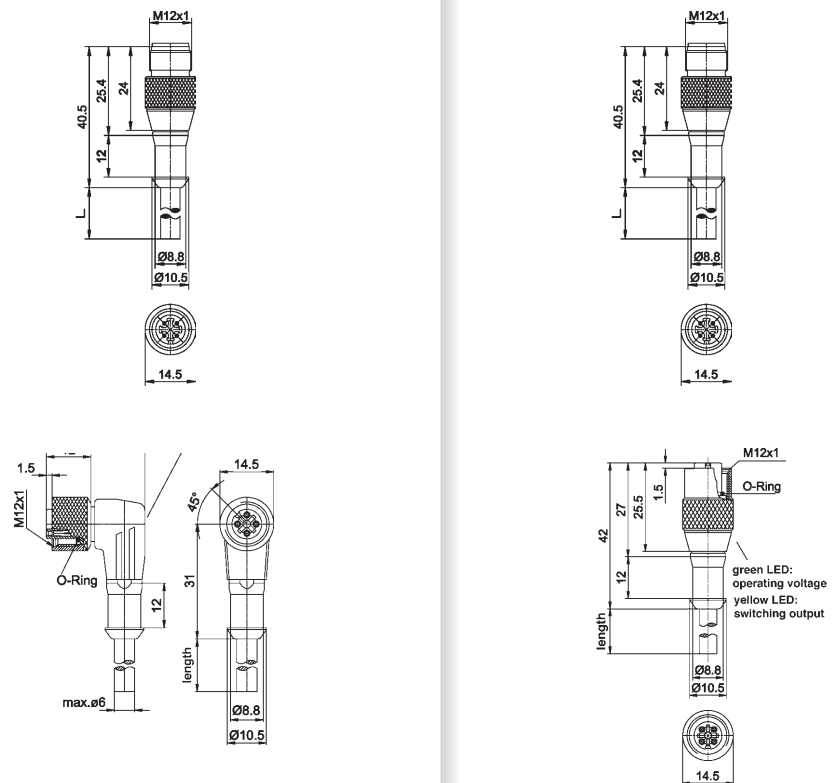
TECHNICAL DATA

voltage (U_N) without LED	-	-
voltage (U_N) with LED	10 ... 30V DC	10 ... 30V DC
display (operating voltage)	green LED (contact 1)	green LED (contact 1)
display (switching output)	2 yellow LEDs (contact 2 and 4)	yellow LED (contact 4)
wire assembly	43 x 0.1mm	43 x 0.1mm
wire cross section	0.34 mm ²	0.34 mm ²
outer jacket	PUR	PUR
ambient temperature	-25 ... +80°C	-25 ... +80°C
system of protection (EN 60529)	IP67	IP67
wire colors	1/brown 2/white 3/blue 4/black	1/brown 2/white 3/blue 4/black

connector:	M12, straight	M12, straight
socket:	2x M8, angular, 2 LED	2x M8, straight
number of pins:	2x 3-pin	2x 3-pin
article-no.	VK030E82	VK030E84
length	0.3m	0.3m
article-no.	VK100E82	VK100E84
length	1.0m	1.0m

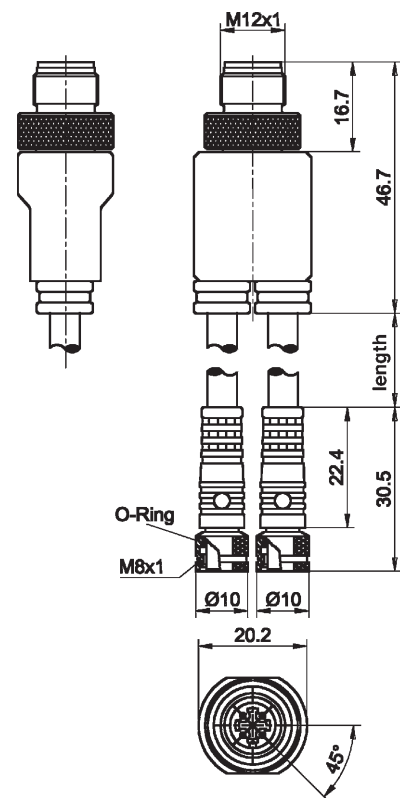
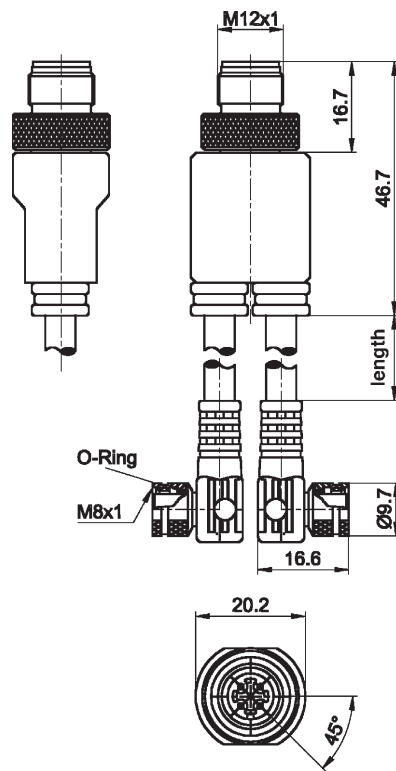

TECHNICAL DATA

voltage (U _N) without LED	-	60V DC / AC _{eff}
voltage (U _N) with LED	10 ... 30V DC	-
display (operating voltage)	green LED (contact 1)	-
display (switching output)	yellow LED (contact 4)	-
wire assembly	43 x 0.1mm	43 x 0.1mm
wire cross section	0.34 mm ²	0.34 mm ²
outer jacket	PUR	PUR
ambient temperature	-25 ... +80°C	-25 ... +80°C
system of protection (EN 60529)	IP67	IP67
wire colors	1/brown 3/blue 4/black	1/brown 3/blue 4/black