

sensing the future



Pressure wave switch

Sensing Edges, Push Buttons and ground contact sensors for automatic doors and gates as well as for public transportation applications

Maintenance free, robust and proven

- Very reliable and sensitive switching characteristics
- Pressure wave technology ensures highest switching reliability
- Simple and extremely robust design
- Millions of units successfully installed and in use

Pressure Wave Switch

For automatic doors and gates as well as for public transportation applications

Universal and ideal wherever a high reliable switching pulse is required

The pressure wave system due to its high sensitivity is able to detect people approaching from almost all sides. Because of the simple design the system is extremely reliable in very tough environments.

Reliable and extremely sensitive

A pressure wave of only 3 to 4 mbar is enough to guarantee a reliable switch of the electrical contact. Pressure wave switch systems are well proven and maintenance free, offering an excellent cost-performance ratio.



Pressure wave switch series

For more detailed information about the individual Pressure wave switch series, please refer to the following pages

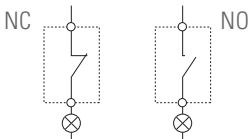
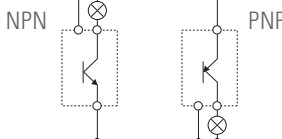
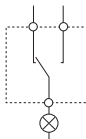

Series Pressure wave switch	D1 DW10–DW40	D2 D2...	D3 D3P /B /V
Response pressure	2 mbar*	0.3–4.5 mbar (3 classes)	2 mbar*
Max. pressure	150 mbar	500 mbar	500 mbar
Min./max. current	20 mA / 500 mA (ACDC ohmic)	1 mA / 500 mA (ACDC ohmic)	1 mA / 1000 mA (ACDC ohmic)
Min./max. operating voltage	24–250 VAC, 24–50 VDC	24 V / 36 V / 48 V	6–250 VAC, 6–50 VDC
Output	NC or NO contact 	Semiconductor, (NPN or PNP) NC or NO contact 	Switch 



How it works

A pressure wave generated by pressing the sensing edge reaches the pressure wave switch. The membrane deflects and the electric contact switches.

The electric contact remains switched as long as the input pressure is above the response pressure.

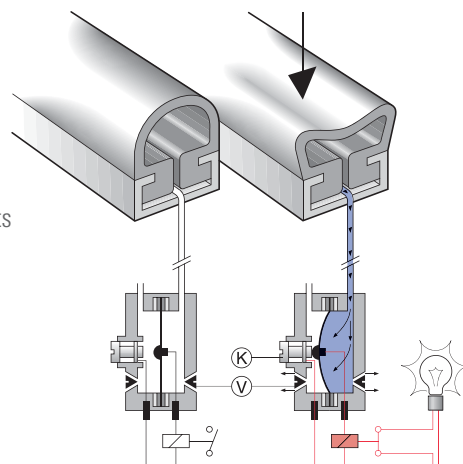

Reliable in every application

Situation

Overhead Door

Solution

- Opening signal: Ground contact sensor DGU
- Safety: Pressure wave profile DWS

Advantages

- The ground contact sensor is very robust and can be driven over by all kinds of vehicles
- The pressure wave profile is very sensitive and switches quickly

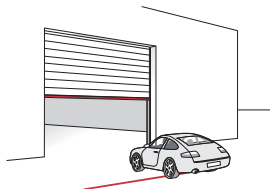

Situation

Barrier

Solution

- Opening signal: Ground contact sensor DGU
- Safety: Pressure wave profile DWS

Advantages

- The ground contact sensor is very robust and can be driven over by all kinds of vehicles
- The pressure wave profile is very sensitive and switches quickly

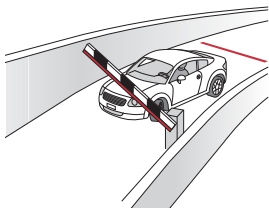

Situation

Bus door

Solution

- Safety: Pressure wave profile DWS

Advantages

- The pressure wave profile is very sensitive and switches quickly
- It protects people from getting injured by the door when the door is closing

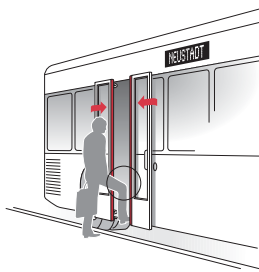

Situation

Vehicle vestibule

Solution

- Opening signal: Pressure sensitive cell DGD
- Safety: Pressure wave profile DWS

Advantages

- The pressure wave sensitive cell DGD is very flat and can be installed flush with the floor. It withstands high loads
- The pressure wave profile is very sensitive and switches quickly



Situation

Sanitary area

Solution

- Sensor: Hand-operated button

Advantages

- Simple and safe activation of electric switching devices in moist environments or rooms with a potentially explosive atmosphere



Pressure wave switch

D1 series pressure wave switch

Millions of units successfully in service

The pressure wave switch from Bircher Reglomat is based on proven technology that has been working perfectly for over 40 years with millions of units installed and in use. The D1 is used in many different applications. Because of its simple and basic design it operates extremely reliably and without any interference from the external environment. A defined orifice equalizes for atmospheric and/or temperature changes.

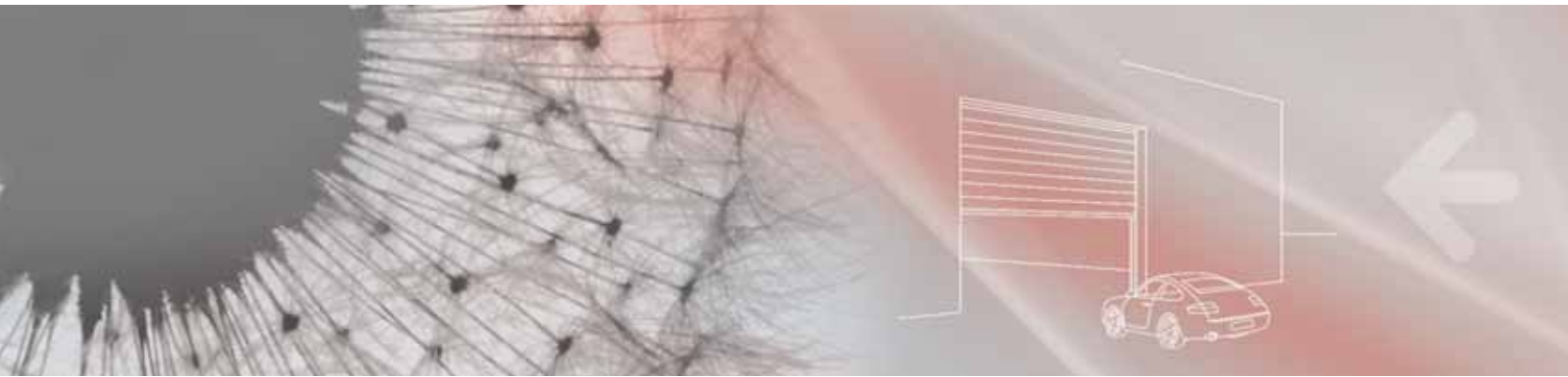

Types of the D1 series

Dimensions in inch (mm)

Opening/closing contact function

Pressure closes

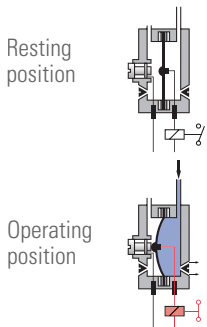

Pressure opens

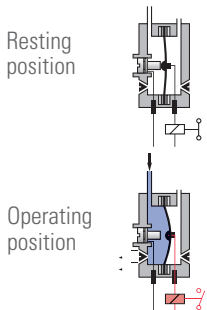

DW10

Pluggable pressure wave switch with connections at bottom

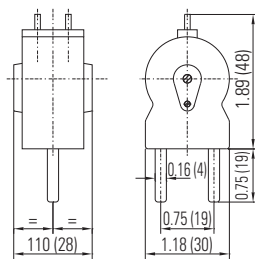

DW20s

Pressure wave switch with screw connections. Easily accessible screw terminals and 0.25" (6.3 mm) blade terminals

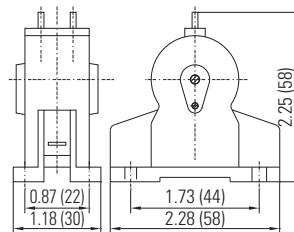

DW10s

Pluggable pressure wave switch with connections on side

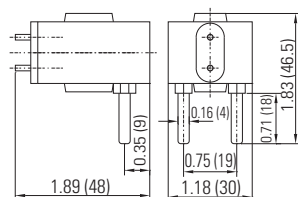

DW40

Pressure wave switch with connection terminals and 0.25" (6.3 mm) plug tab with clip-on mounting bracket

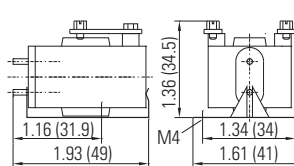

Specifications

- Pressure equalization: 110 ml/min at 2 mbar. Other settings or fully sealed on request
- Mechanical life time: 50 million switchings
- Operating temperature: -20°F to +160°F (-30°C to +70°C)

Ordering information

Type

DW10 209986 DW20s 210004
 DW10s 209999 DW40 210018
 d = Sealed version

The DW40 switch can also be supplied in the housing GEHDWGK11 (see page 11 for housing details) order information for the DW40 switch mounted in this housing is:

DWGK11 210096⁽¹⁾
 DWGK11-DOE 210097⁽²⁾
 DW40 Contacts: ⁽¹⁾ N/O contact
⁽²⁾ N/C contact

Pressure wave switch

D2 series pressure wave switch

Pressure wave switch with electrical output

The D2 series pressure wave switch is used where low currents have to be switched or where electronic self-holding effect is required. As standard the switch has a fixed valve orifice to compensate atmospheric and temperature changes. The Birotil (self-holding) version, on the other hand, operates with a pneumatic self-holding effect.

The D2 series pressure wave switch is equipped with a self-cleaning contact and a double membrane system. It is certified acc. to DEV, VDE and NEMKO.



Types of the D2 Series

Type selection

The D2 pressure wave switch is available in 3 operating pressure ranges:

CI1: 0.3–1.0 mbar

CI2: 1.0–2.0 mbar

CI3: 2.0–4.5 mbar

Each operating pressure range can be set for the corresponding pressure or vacuum

D2 dimensions

in inch (mm)

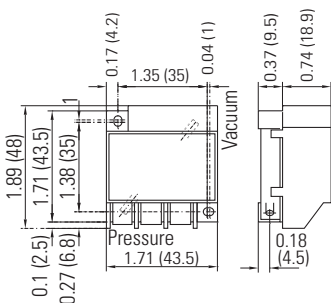

Specifications

- Pressure equalization: sintered filter, fully sealed on request
- Mechanical life time: 30 million switchings
- Operation temperature: -13°F to $+140^{\circ}\text{F}$ (-25°C to $+60^{\circ}\text{C}$)

Ordering information

e.g. CI2 D2 11 KV 24 03 NPN N

Operating pressure ranges

CI1 = 0.3–1.0 mbar

CI2 = 1.0–2.0 mbar

CI3 = 2.0–4.5 mbar

Type

D2

Principle

11 = N.C. normal mounting

12 = N.C. circuit board mounting

13 = N.O. normal mounting

14 = N.O. circuit board mounting

Model

K = Standard

B = Birotil (self-holding)

KV = Standard with delayed release

BV = Birotil with delayed release

Connection voltage

24 V

Release delay

0,3 s; 1,0 s; 3,0 s

Output

NPN, PNP

Housing

Pressure wave switch

D3 series pressure wave switch

Pressure wave switch with snap-action contact

The D3 series pressure wave switch is used for applications where a changeover contact is required as well as where a hysteresis effect is mandatory or where a pneumatic self-holding contact is required. With the D3 Switch the pneumatic system is completely separated from the electrical system. The pressure wave is converted into a linear movement. This linear movement is used to activate the snap-action switch which establishes a defined condition in regards to the contact pressure. The contact pressure is set with the adjusting screw. Three different basic types are available.

The D3 pressure wave switch is equipped with a self-cleaning contact and a snap-action switch. The design of the switch makes it possible to have a pneumatic self-holding contact.



Types of the D3 series

Type selection

D3-P

- A pressure wave activates the snap-action switch
- A valve orifice allows equalization for pressure, e.g. caused by temperature differences
- A sealed version is also available (w/o pressure equalization orifice)

D3-V

- Vacuum activates the snap-action switch
- A sealed version is available (w/o pressure equalization orifice)

D3-PB

- Pressure wave activates the changeover switch
- The additional "Birotil" (self-holding) mechanism ensures that the pressure equalization valve is sealed

D3 dimensions

in inch (mm)

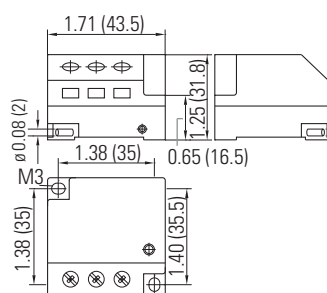

Specifications

- Pressure equalization: 65 ml/min at 2 mbar*, fully sealed on request
- Mechanical life time: 10 million switchings
- Operation temperature: -22°F to +176°F (-30°C to +80°C)

Ordering information

e.g. D3-PB K1

Type

D3-P	209853
D3-V	209872
D3-PB	209854

(K1 = Synthetic Housing)

Pressure wave sensor

Pneumatic pressure wave profiles

Safety with System

When the pressure wave profile gets compressed the air volume inside the profile gets compressed in a pulsed manner and a pressure wave is generated. The air wave travels extremely fast through the connecting hose to the connected pressure wave switch which triggers the contact.



Profile types

General technical data on rubber profiles and prefabricated safety edges can be found on the last page

Dimensions

(Dimensions in inch (mm))

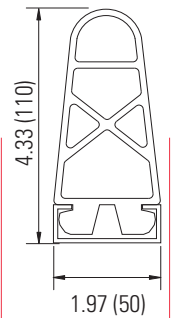
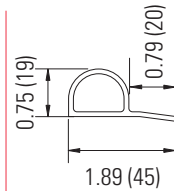
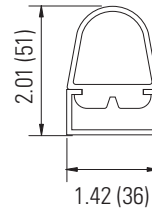
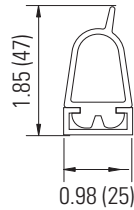
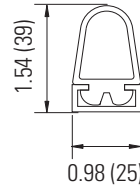
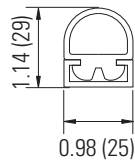
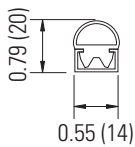

Profile	DWS-D	DWS-C	DWS-B	DWS-Bs	DWS-A	DWS-P	DWS-X
Article no.	210154	210152	210147	210149	210142	210195	210197
Material	PVC black	PVC black	PVC black	PVC black	PVC black	PVC black	PVC black / red
Air cross section	0.12 sq in (77 mm ²)	0.28 sq in (180 mm ²)	0.62 sq in (400 mm ²)	0.62 sq in (400 mm ²)	0.85 sq in (550 mm ²)	0.33 sq in (213 mm ²)	0.85 sq in (550 mm ²)
Max. length	19.7' (6m)	19.7' (6m)	19.7' (6m)	19.7' (6m)	19.7' (6m)	19.7' (6m)	19.7' (6m)
Weight with/without rail *lb/ft (**kg/lfm)	0.18* (0.27**)/ 0.09* (0.14**)	0.44* (0.66**)/ 0.22* (0.33**)	0.50* (0.75**)/ 0.28* (0.42**)	0.52* (0.78**)/ 0.31* (0.46**)	0.87* (1.3**)/ 0.54* (0.8**)	0.20* (0.3**)	1.78* (2.65**)/ 1.44* (2.15**)
Mounting Rail (Dimensions in inch (mm))							
Rail Type	DWSALUD	AP-2	AP-2	AP-2	AP-1		DWSPVCX
Material	Aluminium	Aluminium	Aluminium	Aluminium	Aluminium		PVC

Pressure wave sensor

Ground contact sensor DGU / Pressure sensitive cell DGD

Sensor for the installation in the ground

The ground contact sensor DGU is mostly used as an opening signal transmitter for automatic overhead doors and gates. It is very robust and can be driven over by all kinds of vehicles.

The pressure sensitive cell DGD is frequently used as a sensor in contact floors. It is extremely robust as well, and is also popular because of its flat design and easy installation.



Ground contact sensor DGU

See technical data on the last page

Type selection

The DGU ground contact sensor is available in 6 standard overall lengths.

Stand. overall length A in inch (mm):
21.26 (540), 40.94 (1040), 60.63 (1540), 80.31 (3040), 237.80 (6040)

Stand. effective length B in inch (mm):
19.69 (500), 39.37 (1000), 59.06 (1500), 78.74 (2000), 118.11 (3000), 236.22 (6000)

Installation

During installation make sure that the steel channel base is flush with the ground and only the ribbed part of the rubber profile stands above the surface.

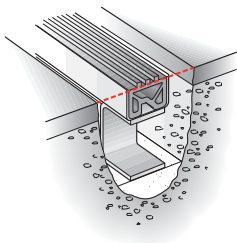

Installation dimensions

in inch (mm)

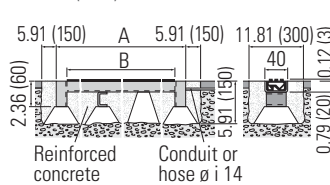

Ordering information

e.g. DGU 3000

Type

Ground contact sensor

Length in inch (mm)

19.69 (500), 39.37 (1000), 59.06 (1500), 78.74 (2000), 118.11 (3000), 236.22 (6000)

e.g. DGUG 1500

Type

Rubber profile for ground contact sensor

Length in inch (mm)

19.69 (500), 39.37 (1000), 59.06 (1500), 78.74 (2000), 118.11 (3000), 236.22 (6000)

Pressure sensitive cell DGD

See technical data on the last page

Sample applications



Exposed DGD



DGD recessed in substructure



DGD recessed in floor plate



DGD centred with ring



DGD centred and levelled with M20 bolt



DGD centred with underlay plate

DGD dimensions

in inch (mm)

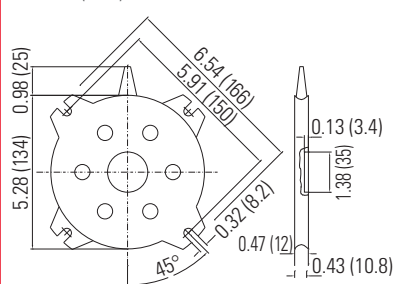

Ordering information

e.g. DGD

Type

DGD pressure sensitive cell

Pressure wave sensor

Pneumatic foot and hand-operated push button DT

Sensor for door and gate opening systems and for moist environments

This reliable and proven products is easy to install. Depending on the application you can select between colored rubber buttons, a hermetically sealed version or a heavy duty version for heavy mechanical loads.



Pneumatic foot and hand-operated push button DT

All dimensions in inch (mm)

Button DTWR

- DTWR version; rubber button in red
- DTWB version; rubber button in blue

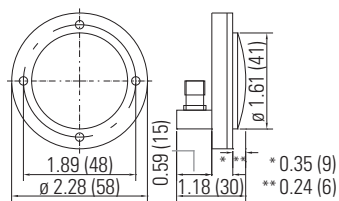

Button DTHB

- Hermetically sealed version
- Blue rubber button

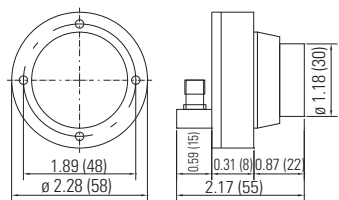

Foot-operated button DTFA

- Visible parts are made from chromium-nickel steel

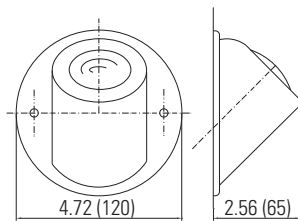

Foot-operated button DTFV

- Heavy-duty version
- Visible parts are made from chromium-nickel steel

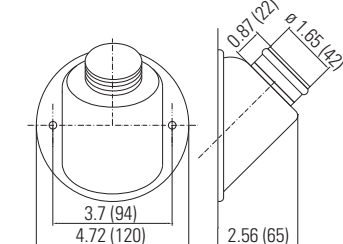

Foot-operated button DTFU Hand-operated button DTFUW

- Visible plate made from chromium-nickel steel
 - Black rubber button
- The DTFUW version is a hand-operated button and comes with an especially soft button.

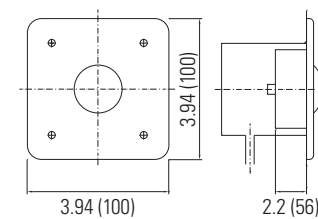

Ordering information Foot and hand-operated buttons DT

e.g. DTFUW

Type

DT button

Variants

- ..FU
- ..FUW
- ..WR
- ..WB
- ..HB
- ..FA
- ..FV

Pressure wave switch and sensors

Connection elements

Easy connection

The pressure wave switch and sensor can be easily connected together in a variety of ways. A wide range of connection pieces and hoses guarantees flexibility and reliable functioning adapting to your application.



Connection elements

All dimensions in inch (mm)

PVC 2/4

PVC air hose with 0.08"/0.16" (2/4 mm) diameter

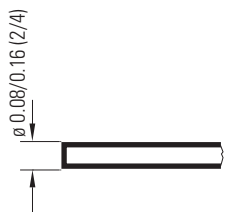

NEO 2/4

Neoprene air hose with 0.08"/0.16" (2/4 mm) diameter

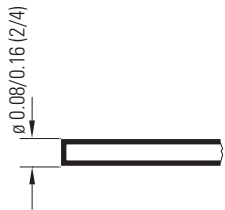

DWV

Straight air hose connection piece

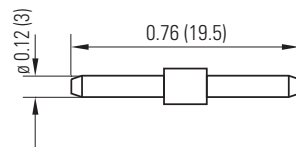

DWL

Air hose connection piece with 90° angle

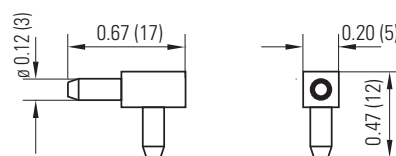

DWT

Air hose connection piece with T-shape

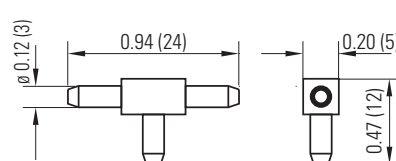

A3M5

Connection piece with two 0.12" (3 mm) diameter connections, thread M5

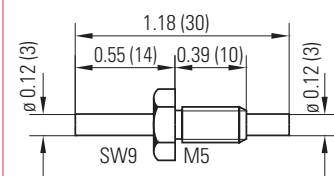

Pressure wave switch

Accessories

Maximum flexibility for your installation

Optimize space in your installation by using one of our plug-in bases. Protect the DW switch against manipulation and external conditions by using a cover hood. The user-friendly housing made out of impact-resistant plastic ensures protection against environmental influences acc. to IP54 (IEC 529).



Plug-in base, cover hood and housing

All dimensions in inch (mm)

DWSO plug-in base

- Space-saving and efficient installation for DW10 and DW10s
- Spring loaded socket
- Easily accessible connection terminals
- Ability to connect 0.25" (6.3 mm) blade terminals

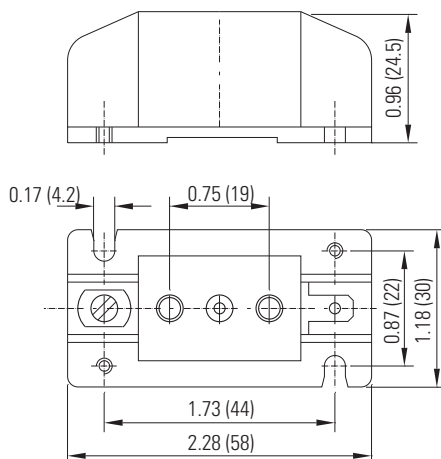

DWH cover hood

- Protects the pressure wave switch against manipulation
- Can be used for DW10 with DWSO, DW20s
- The electrical supply cable can be on one or both sides

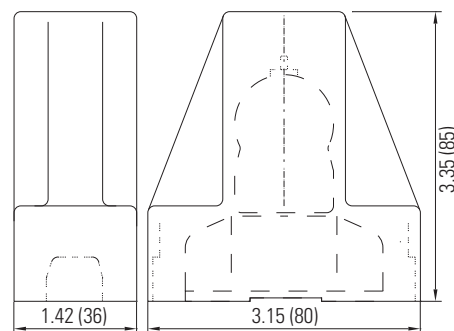

GEHDWGK 11

- Impact-resistant plastic housing for pressure wave switch DW40
- Index of protection IP 54 (IEC 529)

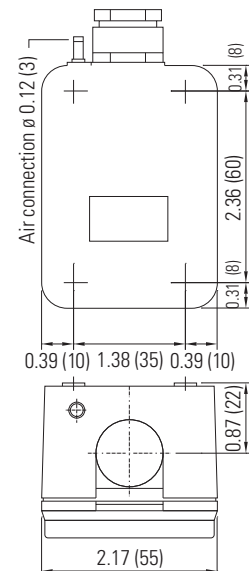

Ordering information

Ground contact sensor DGU

Length	19.69" (500 mm)	39.37" (1000 mm)	59.06" (1500 mm)	
Type	DGU500 209932	DGU1000 209928	DGU1500 209929	
Length	78.74" (2000 mm)	118.11" (3000 mm)	236.22" (6000 mm)	
Type	DGU2000 209930	DGU3000 209931	DGU6000 209934	

Pressure sensitive cell DGD

209926	DGD	DGD pressure sensitive cell	
---------------	------------	-----------------------------	---

Pneumatic foot and hand-operated buttons DT



209985	DTWR	Button DTW, red rubber button	
209984	DTWB	Button DTW, blue rubber button	
209983	DTHB	Button DTHB, hermetically sealed, blue rubber button	
209978	DTFA	Foot-operated button DTFA	
209982	DTFV	Foot-operated button DTFV, heavy-duty version	
209979	DTFU	Foot-operated button DTFU, black rubber button	
209981	DTFUW	Hand-operated button DTFUW, special soft black rubber button	

Connection elements

Length	32.8' (10 m)	82' (25 m)	164' (50 m)	328' (100 m)	
Hose	PVC 2/4 207492	PVC 2/4 207493	PVC 2/4 207494	PVC 2/4 207495	
Hose	NEO 2/4 207499	NEO 2/4 207500	NEO 2/4 207501	NEO 2/4 207502	

208930	DWV	Straight air hose connection piece	
208929	DWL	Air hose connection piece with 90° angle	
208928	DWT	Air hose connection piece with T-shape	
208968	A3M5	Connection piece with dia. 0.12" (dia. 3 mm) connections, thread M5	

Plug-in base, cover hood and housing

210191	DWSO	Plug-in base for DW10 and DW10s	
210123	DWH	Cover hood for DW10 with DWSO, DW20s	
212866	GEHDWGK11	Impact-resistant plastic housing for pressure wave switch DW40	

Technical data

Pneumatic pressure wave profiles

Material	PVC
Profile length	max. 19.7' (6 m)
Connection cable length to PW	max. 32.8' (10 m) dia 0.08"/0.16" (dia 2/4 mm)
Manufacturing tolerances	at 68°F (20°C)
Width/height	± 0.08" (± 2 mm)
Length up to 39" (1000 mm)	± 0.12" (± 3 mm)
Length up to 79" (2000 mm)	± 0.20" (± 5 mm)
Length up to 157" (4000 mm)	± 0.35" (± 9 mm)
Length up to 236" (6000 mm)	± 0.59" (± 15 mm)

Ground contact sensor DGU

Material	U-profile: Galvanized steel Rubber profile: EPDM
Connection cable length to PW	max. 32.8' (10 m) dia 0.08"/0.16" (dia 2/4 mm)
Loading capacity	max. 4400 lbs (2 t)
Drive-over speed	max. 19 mph (30 km/h)
Operating temperature	-4°F to +140°F (-20°C to +60°C)

Pressure sensitive cell DGD

Material	Galvanized steel, natural rubber, ring, protected by silicone
Loading capacity	
Pressure load	max. 11000 lbs/element (5 t)
Preload	max. 88 lbs/element (40 kg)
Response weight	approx. 11 lbs/element (5 kg)
Deformation	0.008"/22.5 lbf (0.2 mm/100 N)
Max. deformation	0.047"/135 lbf (1.2 mm/600 N)
Number of elements/system	max. 8
Operating temperature	-4°F to +160°F (-20°C to +70°C)

Housing GEHDWGK-11

Material	Impact-resistant plastic, Luran 786R, grey
Weight	3 oz (85 g) / 1.6 oz (45 g) empty
Fastening	2 x M4 screw
Electrical connection	PG-cable gland PG11
Air connection	Connection nipple dia. 0.12" (dia. 3 mm)
Protection class	IP 54 (IEC 529)

Note

Technical details and recommendations concerning our products are based on experience and are an aid for the orientation of the user. Details stated in our brochures and data sheets do not guarantee special properties of the products. This does not apply to special product properties confirmed by us in writing or individually. Subject to technical alterations.

Your contacts

Bircher America Inc.

909 East Oakton Street
Elk Grove Village, IL 60007
USA

Phone +1 800 252 1272

Fax +1 847 952 2005

sales@bircherreglomat.com

www.bircherreglomat.com