

# VME64x System Subrack 1 U

## User's Manual



**Product No.:**  
**20836-145**

---

Rev.	Date updated	Change
R1.0	November 09, 2007	Initial Release

Impressum:

Schroff GmbH

D-75334 Straubenhardt, Germany

The details in this manual have been carefully compiled and checked - supported by certified Quality Management System to EN ISO 9001/2000

The company cannot accept any liability for errors or misprints. The company reserves the right to amendments of technical specifications due to further development and improvement of products.

Copyright © 2007

All rights and technical modifications reserved.

---

## Table of Contents

<b>1</b>	<b>Safety</b> .....	<b>1</b>
1.1	Intended Application .....	1
1.2	Safety Instructions .....	2
1.2.1	Safety Symbols used in this document .....	2
1.3	General Safety Precautions .....	2
1.4	References and Architecture Specifications .....	3
<b>2</b>	<b>Equipment description</b> .....	<b>4</b>
2.1	Subrack System Overview .....	4
2.2	Subrack: .....	4
2.3	VME64x Backplane .....	5
2.4	Power Supply .....	6
2.4.1	Grounding/Earthing .....	6
2.4.2	ATX Power Supply .....	7
2.4.3	Wiring Diagram .....	8
2.5	Cooling .....	9
<b>3</b>	<b>Assembly</b> .....	<b>10</b>
3.1	General Assembly Guidelines .....	10
3.1.1	Unpacking .....	10
3.1.2	Ensuring Proper Airflow .....	10
3.2	Rack-Mounting .....	11
<b>4</b>	<b>Service</b> .....	<b>12</b>
4.1	Technical support and Return for Service Assistance .....	12
4.2	Declaration of Conformity .....	12
4.3	Delivery comprises .....	13
4.4	Accessories .....	13
4.5	Replacement Parts .....	13
<b>5</b>	<b>Technical Data</b> .....	<b>14</b>
<b>6</b>	<b>Dimensions</b> .....	<b>15</b>



# 1 Safety

## 1.1 Intended Application

The VME64x system subrack, described in this manual, is intended as a platform for a microcomputer system based on the VME64x bus system (VITA 1.1-1997).

The VME64x system subracks are designed for protection class IP 20 and can be used only in the resp. environments.

For higher protection requirements, a.e. IP 54/55 you must install the system subrack in a protective case.

VME64x system subracks are not finished products, so there is no valid approval for these units. In order to enable stand-alone functionality, additional elements are required. An operational system is achieved only by way of appropriate VME64x boards.

The completion and final testing of the units have been carried out, or at least supervised, by qualified technicians. These instructions are directed exclusively to these qualified technicians i.e. engineers, trained and qualified electricians etc.



Make sure that:

- the assembled unit complies with the safety regulations currently applicable in the country it is going to be used.
- the overall unit complies with all other regulations and specifications at the place and country of use, e.g. interference limits, approval by the telecommunications authorities.

## 1.2 Safety Instructions

The intended audience of this User's Manual is system integrators and hardware/software engineers.

### 1.2.1 Safety Symbols used in this document

	<p><b>Hazardous voltage!</b></p> <p><i>This is the electrical hazard symbol. Familiarise yourself with the danger of electrical voltages and the safety precautions to avoid accidents before starting to work with parts that carry dangerous voltages.</i></p>
	<p><b>Caution!</b></p> <p><i>This is the user caution symbol. It indicates a condition where damage of the equipment or injury of the service personnel could occur. To reduce the risk of damage or injury, follow all steps or procedures as instructed.</i></p>
	<p><b>Danger of electrostatic discharge!</b></p> <p><i>Static electricity can damage sensitive components in a system. To avoid damage, wear ESD wrist straps or at regular intervals touch blank enclosure parts.</i></p>

## 1.3 General Safety Precautions

	<p><b>Warning!</b></p> <p><i>Voltages over 60 VDC can be present in this equipment. This equipment is intended to be accessed, to be installed and maintained by qualified and trained service personnel only.</i></p> <p><i>This equipment is designed in accordance with protection class 1!</i></p> <p><i>It must therefore be operated only with protective GND/earth connection!</i></p>
---	---

- Service personnel must know the necessary electrical safety, wiring and connection practices for installing this equipment in a telecommunication environment.
- Install this equipment only in compliance with local and national electrical codes.

## 1.4 References and Architecture Specifications

- User Manual VME64x Backplanes  
Order no.: 73972-103
- Short Form User Manual VME64x J1/J2 Monolithic Backplanes  
Order no.: 73972-128

Further information can also be found in the catalogue „Electronic Packaging“ and on the internet under [www.schroff.biz](http://www.schroff.biz)

## 2 Equipment description

The Schroff VME64x System Subrack consists of:

- A shielded 19" subrack with 2 slot board cage for the assembly of 6 U boards in accordance with VME64x standard (VITA 1.1-1997)
- A 2 slot VME64x (VITA 1.1-1997) backplane
- An ATX power supply (250 W) with global input range
- Fans for the active cooling of the boards
- DC switch

### 2.1 Subrack System Overview

Figure 1: Subrack System Overview

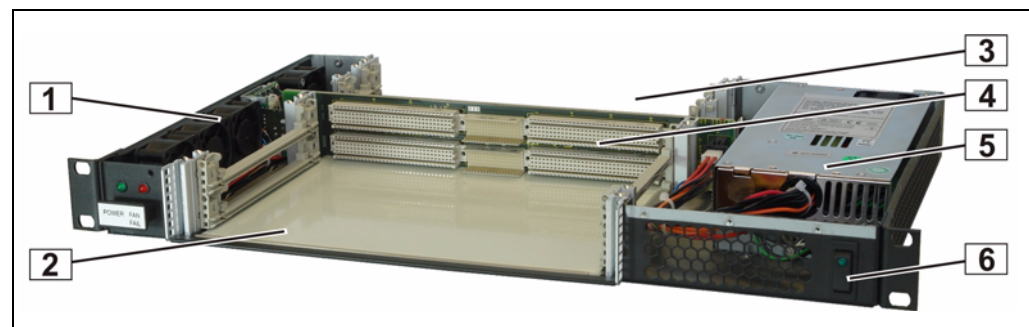

10006853

- |   |                                   |   |                  |
|---|-----------------------------------|---|------------------|
| 1 | Fan Tray                          | 4 | VME64x backplane |
| 2 | Front Board cage with guide rails | 5 | ATX Power Supply |
| 3 | Rear Board cage with guide rails  | 6 | DC Switch        |

### 2.2 Subrack:

The 1 U 19" subrack is based on the Schroff europacPRO system with EMC shielding. The board cage enables the horizontal assembly of 2 VME64x front boards (6 U, 4 HP, 160 mm deep) and 2 Rear I/O Boards (6 U, 4 HP, 80 mm deep).

The right guide rails of the board cage are equipped with ESD clips.



## 2.3 VME64x Backplane

The horizontally assembled 6 U backplane (J1.J2 Monolithic) with P0 connectors conforms to:

VITA 1.1-1997

VITA 38 systems management for VME



At the right side is a connector for the power supply, at the left side a connector for the Fan Tray.

Further information can be found in the user manual of the backplane:  
Order-No. 73972-103, in the catalogue or on the internet at [www.schroff.biz](http://www.schroff.biz)



*1 Slot = 4 HP = 20,32 mm*

## 2.4 Power Supply

	<p><b>Hazardous voltage!</b> <i>Parts of the power supply may be exposed with hazardous voltage. Always remove mains/line connector before carry out any assembly work.</i></p>
	<p><b>Caution!</b> <i>Your system has not been provided with a AC power cable. Purchase a AC power cable that is approved for use in your country. The AC power cable must be rated for the product and for the voltage and current marked on the product's electrical ratings label. The voltage and current rating of the cable should be greater than the ratings marked on the product.</i></p>

Power is provided through a 250 W ATX power supply with wide range input. The power supply is located to the right of the board cage behind a perforated front panel. The AC input is via an IEC 320-C14 connector at the back.

The mains on/off switch is located at the back close to the AC input connector. With a DC switch at the front you can switch-off the DC outputs of the power supply.

### 2.4.1 Grounding/Earthing

	<p><b>Caution!</b> <i>The unit is designed in accordance with protection class 1! It must therefore be operated with protective earth/GND connection. Use only a three conductor AC power cable with a protective earth conductor that meets the IEC safety standards!</i></p>
---	--

## 2.4.2 ATX Power Supply

Figure 2: ATX Power Supply

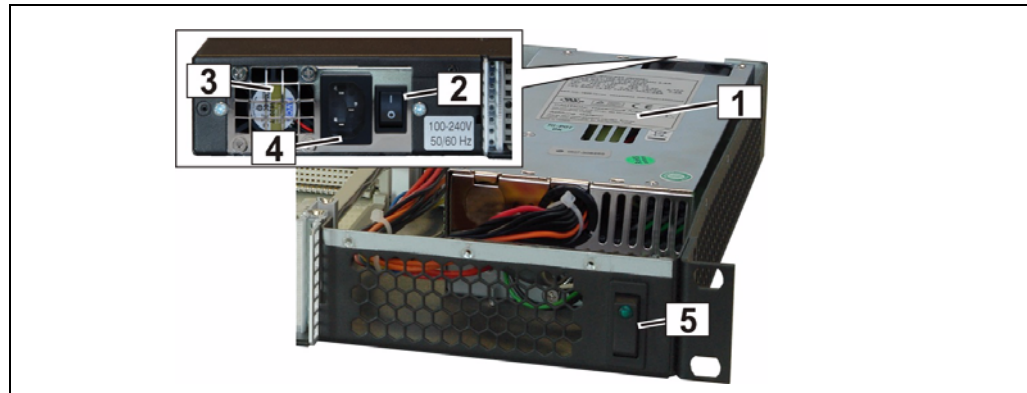

10006854

- |   |                  |   |              |
|---|------------------|---|--------------|
| 1 | ATX Power Supply | 4 | AC Connector |
| 2 | AC Switch        | 5 | DC Switch    |
| 3 | Fan              |   |              |

Table 1: Techn. Daten AC Netzgerät

Input voltage	90...264 VAC, 120...380 VDC / active PFC
Input frequency	47...63 Hz
Input current	4 A (115 V) / 2 A (230 V)
Output (max)	5 V / 23 A; 3,3 V / 14 A, 12 V / 16 A, -12 V / 0,5 A)
Inrush Current	65/130 A (115/230 VAC)
Efficiency	>70%, (115 VAC full load)
Overload protection	110...160%, shut down
Short circuit protection	+3,3 V, +5 V, +12 V, shut down / -5 V, -12 V, +5 VSB, auto recovery
Over voltage protection	+3,3 V (+3,6...+4,2 V), +5 V (+5,6...+6,6 V), +12 V (13,2...14,6 V)
Ripple	+3,3 V 60 mV / +5 V 50 mV / +12 V 120 mV / -12 V 120 mV
Load regulation	+3,3 V ±5% / +5 V ±5% / +12 V ±5% / -12 V ±10%
Hold up time	>16 msec.
Power Good Signal	switch-on delay 100...500 msec. Switch-off delay 1msec.
Isolation voltage	Input / Chassis 3000 VAC for 60 sec. Input / Output 1800 VAC for 60 sec.
Leakage current	<3,5 mA, 115 VAC / 230 VAC
Operating temperature	0...+50°C
Derating	Power on: +3,3 V: +30°C/14 A, +40°C/12 A, +50°C/10 A
Storage temperature	-20...+80°C
Humidity	20...80% RH, non-condensing
MTBF	120.000 h at +50°C, without fan
Safety	TÜV EN 60950 / UL 60950
EMV	CE
Fan	ball bearing fan, temperature regulated
Dimensions (LxBxH)	190 x 100 x 40 mm, ±0,5mm

### 2.4.3 Wiring Diagram

Figure 3: Wiring Diagram

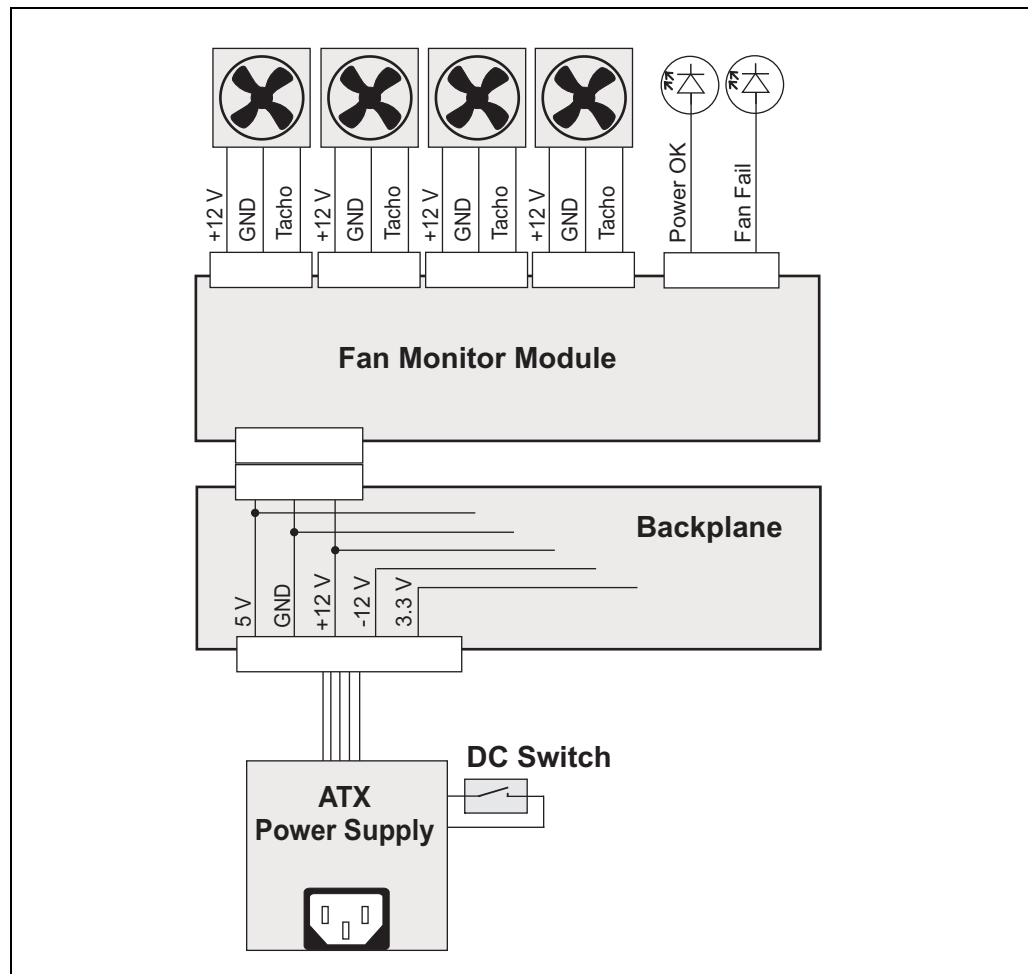

10006857

## 2.5 Cooling

Figure 4: Fan Tray

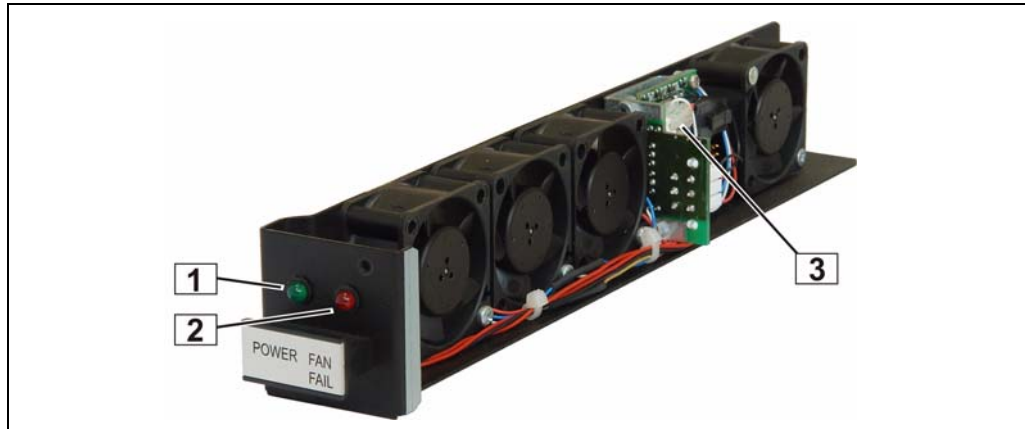

10006856

- |   |              |   |                          |
|---|--------------|---|--------------------------|
| 1 | Power LED    | 3 | Fan Monitor Module (FMM) |
| 2 | Fan Fail LED |   |                          |

The boards are cooled by forced air convection through four 12 VDC axial fans (13,5 m<sup>3</sup>/h (8 cfm) each).

The fans and the Fan Monitor Module (FMM) are located at the Fan Tray.

The fan speed is monitored by the Fan Monitor Module (FMM). When the fan speed drops 20% below nominal fan speed, the FMM will signal a fault condition with the red Fan Fail LED.



### Caution!

*To maintain proper airflow, all open slots must be covered with filler panels. The filler panel should include an airflow baffle that extends to backplane.*

Figure 5: Airflow

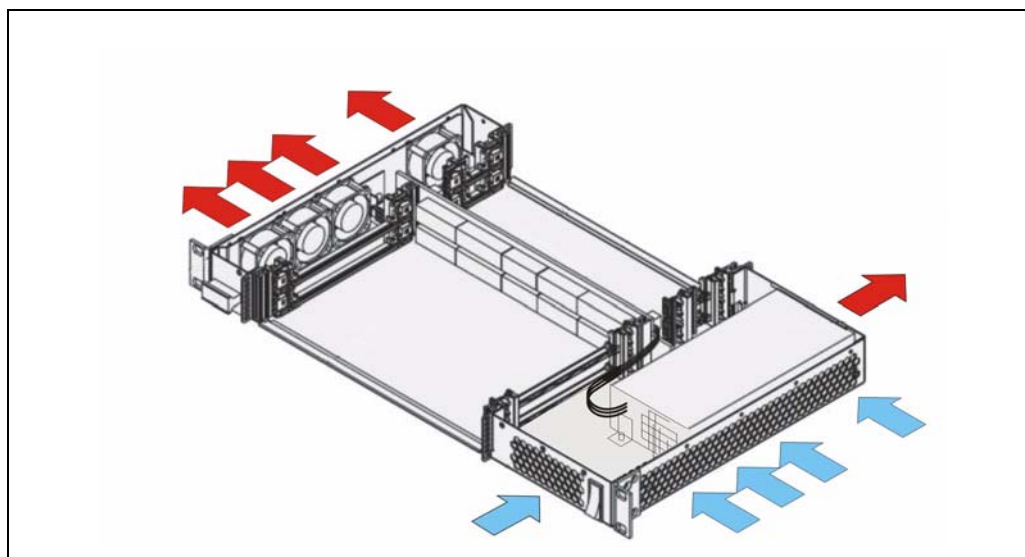

10006855

## 3 Assembly

### 3.1 General Assembly Guidelines

#### 3.1.1 Unpacking



**Caution!**

*When opening the shipping carton, use caution to avoid damaging the system.*

Consider the following when unpacking and storing the system:

- Leave the system packed until it is needed for immediate installation.
- After unpacking the system, save and store the packaging material in case the system must be returned.

If the packaging is damaged and possible system damage is present, report to the shipper and analyze the damage.

#### 3.1.2 Ensuring Proper Airflow

- Install the system in an open rack whenever possible. If installation in an enclosed rack is unavoidable, ensure that the rack has adequate ventilation.
- Maintain ambient airflow to ensure normal operation. If the airflow is blocked or restricted, or if the intake air is too warm, an over temperature condition can occur.
- Ensure that cables from other equipment do not obstruct the airflow through the systems.
- Use filler panels to cover all empty chassis slots. The filler panel prevents fan air from escaping out of the front of an open slot.



**Caution!**

*To maintain proper airflow, all open slots must be covered with filler panels. The filler panel should include an airflow baffle that extends to backplane.*

## 3.2 Rack-Mounting

This subrack system can be installed in 19" equipment racks. The rack must be accessible from the front and rear for equipment installation.

### Mounting Instructions:

- Ensure that the rack is constructed to support the weight and dimensions of the system.
- Install any stabilizers that came with your equipment rack before mounting or servicing the system in the rack.
- Load the rack from the bottom to the top, with the heaviest system at the bottom, avoid uneven mechanical loading of the rack.

**Tabelle 2: Commissioning**

	<p><b>Warning!</b></p> <p><i>Voltages over 60 VDC can be present in this equipment. This equipment is intended to be accessed, to be installed and maintained by qualified and trained service personnel only.</i></p> <p><i>This equipment is designed in accordance with protection class 1!</i></p> <p><i>It must therefore be operated only with protective GND/earth connection!</i></p>
---	---

Before the commissioning of the system the following tasks have to be carried out:

- Ensure that the system has not been damaged during transport, storage or assembly.
- Carry out a new test for the protective earth – set value < 0.1 Ohm
- Switch on the system and check all VME64x voltages directly on the backplane before the board assembly.
- Plug-in the boards
- Cover the vacant slots with air flow barriers

## 4 Service

### 4.1 Technical support and Return for Service Assistance

We generally recommend to return the complete subrack system. For all product returns and support issues, please contact your Schroff sales distributor or [www.schroff.biz](http://www.schroff.biz).

We recommend that you save the packing material. Shipping without the original packing material might void the warranty.

### 4.2 Declaration of Conformity

VME64x systems are not an end product. In order to make them operational, further assemblies are necessary.

In accordance with the definition in the EMC directives it is not classified as equipment, therefore a CE certification is not required. The systems do, however, fulfil all requirements in a full assembled state to the standard of EMC guideline 89/336/EWG and the low voltage guideline 73/23/EWG. Generally the systems are equipped with power supplies, which have a CE certification (EN 60950, EN 61000-6-3, EN 61000-6-2).

The selection of the filter elements is carried out with consideration of the hysteresis curve to EN 55022, class B. Interference resistance is guaranteed in accordance with EN 61000-6-2. Shielding measurements in the frequency area of 30 MHz to 1000 MHz to VG directive 95 373, Part 15, are carried out.

The systems were developed and manufactured in accordance with EN 60950. Before delivery each systems undergoes a voltage, protective earth and functionality test.



### 4.3 Delivery comprises

Quantity	Description
1	19" subrack, shielded, black powder coated (RAL9005)
1	VME64x backplane (VITA 1.1-1997), 2 slot 6 U with P0 connectors
1	Front card cage for max. 2 boards 6 U 160 mm deep IEEE guide rails inc. ESD clips (ESD clip assembled at the right)
1	Rear card cage for max. 2 boards 6 U 80 mm deep IEEE guide rails inc. ESD clips
1	250 W ATX power supply with input range of 100 VAC to 240 VAC with 4 voltages: 3,3 V / 14 A; 5 V / 23 A; 12 V / 16 A; -12 V / 0,5 A)
1	Complete AC/DC cabling
1	DC switch
1	Fan Tray, hot swappable

### 4.4 Accessories

Order No.	Description
20848-7xx	Slot covers with front panel and EMC shielding for vacant slots. For dimensions, please see catalogue.
34562-8xx	Slot covers for vacant slots. For dimensions, please see catalogue.
24579-03x	Board covers. For dimensions, please see catalogue

### 4.5 Replacement Parts

On request.

## 5 Technical Data

Table 3: Technical Data

<b>Dimensions</b>	
Height	42 mm
Width	482.80 mm (19")
Depth	283,25 mm
<b>Weight</b>	
Completely assembled	5 kg
<b>Power Supply</b>	
Input Voltage	100 VAC bis 240 VAC
Frequency	50 / 60 Hz
Power input	up to 250 W
<b>Cooling</b>	
4 x 12 VDC fans	13.5 m³/h (8 cfm) each, free blow
<b>Ambient Temperature</b>	
Operation	+0 °C to +40 °C
Storage	-40 °C to +85 °C
<b>Humidity</b>	
Admissible humidity	30 % to 80 %, non-condensing
<b>EMC, fulfils requirements for:</b>	
Transient Emissions	EN 55022
Interference Resistance	EN 55024
<b>Safety</b>	
Test voltages according to EN 60950	Input - Output: 4,3 kVDC Input - PE: 2,2 kVDC Output - PE: 0,7 kVDC Output - Output: 0,7 kVDC
Shock and vibration:	EN 60068-2-6 and EN 60068-2-27
<b>Electromagnetic Shielding</b>	
Shielding attenuation	typ. 40 dB at 1 GHz if shielded front panels are used.

## 6 Dimensions

Figure 6: Dimensions

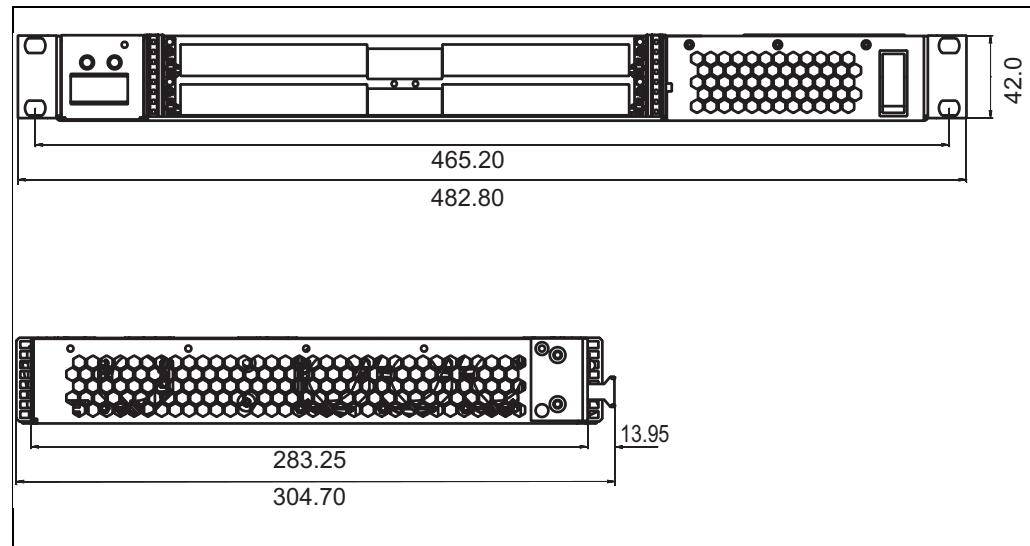

10006858





**SCHROFF GMBH**

**[www.schroff.biz](http://www.schroff.biz)**

**Langenalberstr. 96-100  
D-75334 Straubenhardt**

**Tel.: + 49 (0) 7082 794-0**

**Fax: +49 (0) 7082 794-200**