

IAP-W510

➤ **Industrial outdoor IEEE 802.11 a/n wireless access point with 1x10/100Base-T(X), IP-67 grade**

Features

- High Speed Air Connectivity: WLAN interface support up to 300Mbps link speed
- Highly Security Capability: WEP/WPA/WPA-PSK(TKIP,AES)/ WPA2/ WPA2-PSK(TKIP,AES)/802.1X Authentication supported
- **High throughput**
- **High power output of 500 mW**
- **Far Distance Air Connectivity up to 10 km**
- **Supports X-Roaming < 100 ms**
- **Supports wireless load balance**
- Supports AP/Bridge/Repeater/AP-Client/Client Mode
- Wireless connecting status monitoring
- HTTPs protocol supported for secured management
- Event Warning by Syslog, Email, SNMP Trap
- Rigid IP-67 housing design
- Pole and Wall-mount enabled



Introduction

IAP-W510 is a reliable IP-67 outdoor IEEE 802.11 a/n WLAN Access Point with 1 waterproof Ethernet port. It can be configured to operate in AP/Bridge/Repeater/AP-Client/Client mode. In combination with its IP-67 design and the superb management functionality, IAP-W510 is specifically designed for the toughest industrial environments and provides a waterproof, dust-tight connection. In addition, IAP-W510 provides high power output of 500mW and high throughput to satisfy far distance connection. You are able to configure IAP-W510 by WEB interface via LAN port or WLAN interface. The IAP-W510 can be easily adopted in almost all kinds of applications and provides the most rugged solutions for managing your network in outdoor. Therefore, IAP-W510 is one of the best outdoor communication solutions for wireless applications.

Application

In practical operation of wireless access point, Windows utility (AP-Tool) is supported. This utility is very helpful for you to search and configure IP of access point on the industrial wireless network. In addition, the wireless access point support various kinds of operation modes include AP/ Bridge/Repeater/AP-Client/Client mode. IAP-W510 also can connect to each other up to 10,000 meters with built-in panel antenna. You can build up the wireless network easily.

Various Kinds of Operation Modes

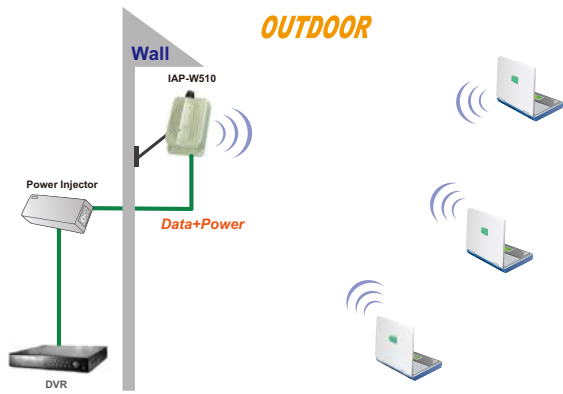

AP Mode

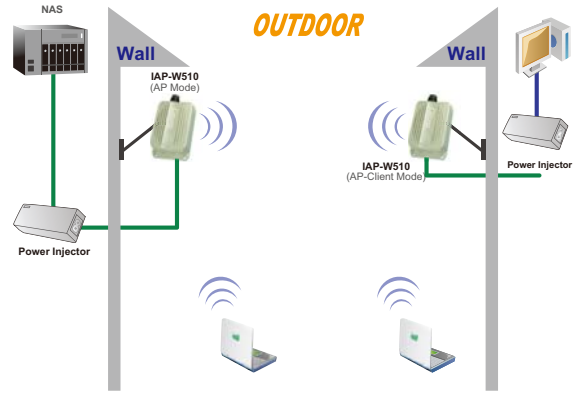

AP-Client Mode

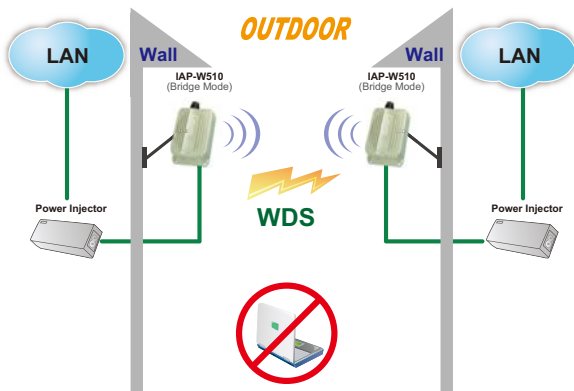

Bridge Mode

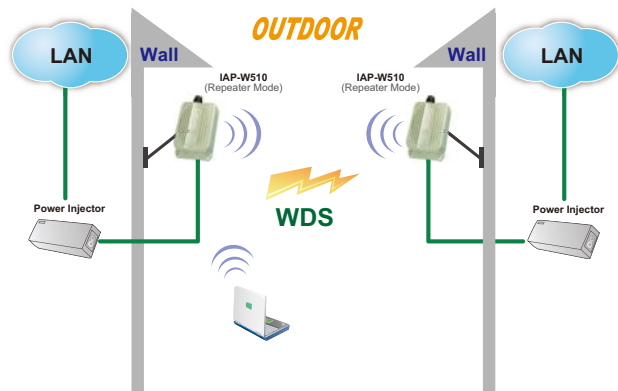

Repeater Mode

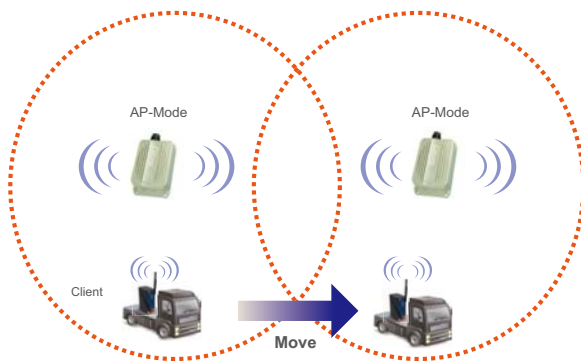

X-Roaming

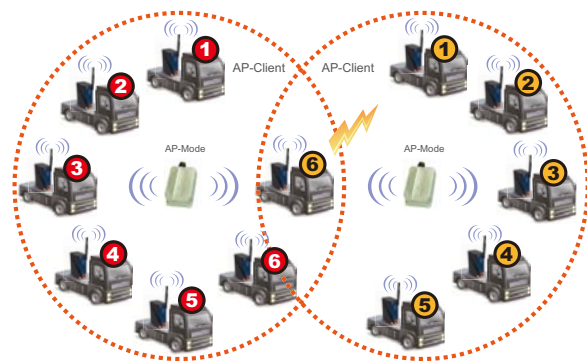

Wireless Load Balance

Dimensions

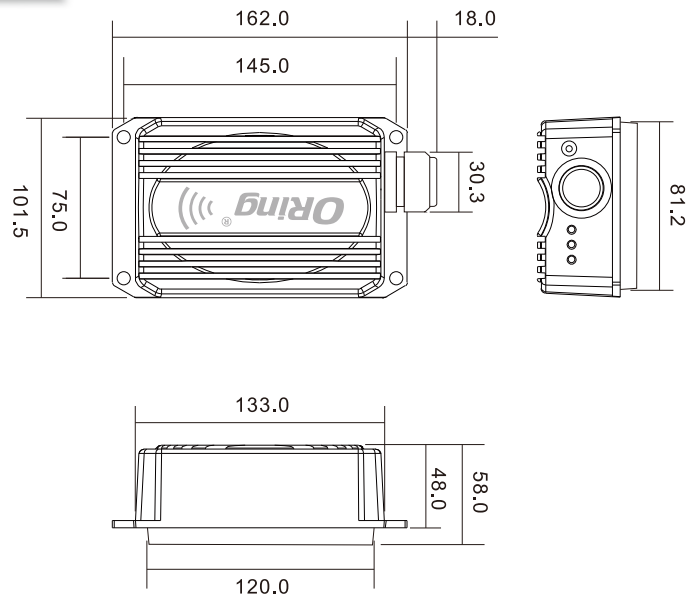

Unit=mm

Specifications

| ORing WLAN Access Point Model | IAP-W510 |
|---|---|
| Physical Ports | |
| 10/100 Base-T(X) Ports in RJ45 Auto MDI/MDIX | 1 |
| WLAN interface | |
| Operating Mode | AP/Bridge/Repeater/AP-Client/Client |
| Antenna Connector | Built-in 15dBi panel antenna |
| Radio Frequency Type | OFDM |
| Modulation | IEEE802.11a : OFDM with BPSK, QPSK, QAM, 64QAM IEEE802.11n : BPSK, QPSK, 16-QAM, 64-QAM |
| Frequency Band | America / FCC : 5.15 to 5.825 GHz (13 channels) Europe CE / ETSI : 5.15 to 5.724 GHz (19 channels) |
| Transmission Rate | IEEE802.11a : 6/ 9/ 12/ 18/ 24/ 36/ 48/ 54 Mbps IEEE801.11n : 300Mbps |
| Transmit Power | IEEE802.11a/n: 500mW |
| Receiver Sensitivity | -82dBm @ 54Mbps, PER< 10%; -78dBm@MCS 15(11n, 20MHz), PER< 10%; -75dBm@MCS 15(11n, 40MHz), PER< 10% |
| Encryption Security | WEP : (64-bit , 128-bit key supported) WPA/WPA2 :802.11i(WEP and AES encryption) WPA-PSK (256-bit key pre-shared key supported) 802.1X Authentication supported TKIP encryption |
| Wireless Security | SSID broadcast disable |
| Protocol Support | |
| Protocol | ARP,BOOTP, DHCP, DNS, , HTTPs, IP, ICMP, SNTp,TCP, UDP, RADIUS, SNMP, STP (IEEE 802.1D) |
| LED indicators | |
| Power indicator | PWR / Ready Green On: Power is on and functioning Normally. |
| 10/100Base-T(X) RJ45 port indicator | Green On: Port Link Green Blinking: Transmitting data |
| WLAN LED | Green for WLAN Link/ Act |

| Power | |
|--------------------------|--|
| Input Power | 48VDC on RJ45 |
| Power Consumption (Typ.) | 9 Watts |
| Physical Characteristics | |
| Enclosure | IP-67 |
| Dimensions (W x D x H) | 162(W)x 102(D)x 58(H) mm (6.38x 4.02x 2.28 inch.) |
| Weight (g) | 680 g |
| Environmental | |
| Storage Temperature | -30 to 85°C (-22 to 185°F) |
| Operating Temperature | -20 to 70°C (-4 to 158°F) |
| Operating Humidity | 0~100% Non-condensing |
| Regulatory Approvals | |
| EMI | FCC Part 15, CISPR (EN55022) class A |
| EMS | EN61000-4-2 (ESD), EN61000-4-3 (RS), EN61000-4-4 (EFT), EN61000-4-5 (Surge), EN61000-4-6 (CS), EN61000-4-8, EN61000-4-11 |
| Shock | IEC60068-2-27 |
| Free Fall | IEC60068-2-32 |
| Vibration | IEC60068-2-6 |
| Safety | EN60950-1 |
| Warranty | 3 years |

Ordering Information

IAP-W **A** **B** 0

| Code Definition | Wireless Mode | 10/100Base-T(X) Port Number |
|-----------------|--|-----------------------------|
| Option | <ul style="list-style-type: none"> - 1: IEEE 802.11 b/g - 2: IEEE 802.11 a - 3: IEEE 802.11 a/b/g - 4: IEEE 802.11 b/g/n - 5: IEEE 802.11 a/n - 6: IEEE 802.11 a/b/g/n | -" 1 ": 1 port |

| Available Model | Model Name | Description |
|-----------------|-------------|---|
| | IAP-W510_US | Industrial outdoor IEEE 802.11 a/n wireless access point with 1x10/100Base-T(X), IP-67 grade, US band |
| | IAP-W510_EU | Industrial outdoor IEEE 802.11 a/n wireless access point with 1x10/100Base-T(X), IP-67 grade, EU band |

Packing List

- IAP- W510
- Wall/Pole Mount Kit
- Power Injector
- ORing Tool CD
- Quick Installation Guide